



**System overview**  
*Viper Edition, 2025*

**VIPER**  
EDITION

MADE FOR  
**Rooters**<sup>®</sup>

Dear ROOTTERS,

Welcome to the Viper Edition of the ROOTT dental implant system.

In this latest edition, we've streamlined the system to enhance functionality while minimizing component count. We've integrated cutting-edge research to refine our design, ensuring it's safer, more user-friendly, and better suited for the digital demands of today's industry. We trust you'll appreciate the updates and continue to share your invaluable suggestions for ongoing improvements.

Warmest regards,  
*Siarhei Shulezhka*  
President



### Established Presence

Celebrating 14 years of excellence in dental innovation



### Global Trust

Over 2.5 million implants successfully placed worldwide



### International Reach

Serving smiles in more than 80 countries across the globe

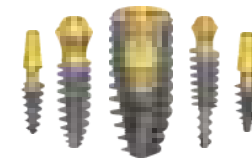

### Diverse Solutions

Offering a suite of five distinct implant types, each tailored for specific clinical needs

# ROOTT **R**

## Discover the ROOTT R Viper Edition – a Pinnacle of Dental Implant Technology

This state-of-the-art implant system sets a new standard with its unparalleled stability and leak-resistant conical connection. It's designed for versatility, featuring adaptive platform switching and a passive fit connection that excels in scenarios demanding additional load capacity.

**Choose ROOTT R for a future-proof, reliable implant solution**



Delivers primary stability  
for a predictable outcome



Precision-engineered conical  
connection for seamless fit  
and enhanced durability



Innovative platform switching  
for optimal tissue preservation  
and aesthetic results



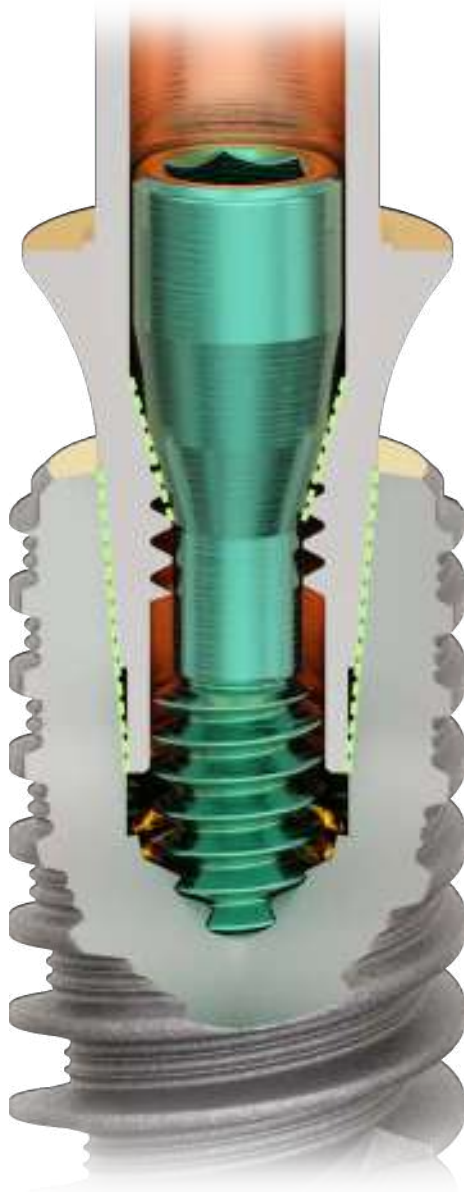

## ROOTT R 5° Taper Connection: Engineered for Excellence

- **Enhanced Stability & Longevity**

Precise 5° conical connection ensures optimal load distribution, secure abutment fit, and minimized micro-movements for long-term implant and bone health.

- **Simplified & Predictable Workflow**

Streamlined design facilitates accurate seating, reduces complexity, and minimizes screw loosening, leading to faster, more predictable restorations.

- **Increased Clinical Confidence & Efficiency**

Reliable biomechanical integrity, reduced inventory, and user-friendly design empower clinicians with greater confidence and simplify training.



- **One Size Fits All**

Unified One prosthetic connection for ROOTT R reduces the number of components to a minimum, optimizing the handling requirements in the daily practice.





## The Unmatched Convenience of ROOTT R Implants' All-In-One Packaging

Streamlined Surgery to Prosthetics with Digital Workflow. This innovative kit includes all vital components from the cover screw to the abutment, eliminating the need for additional purchases.

Each Viper Edition implant comes with

- Cover Screw
- ZeroBoneLoss® abutment
- Fixing Screw for abutment

**ZBL is available in the digital libraries for fully digital workflow**

	6 mm	8 mm	10 mm	12 mm	14 mm	16 mm	18 mm	20 mm
∅ 3.0			R3010	R3012	R3014	R3016		
∅ 3.5	R3506	R3508	R3510	R3512	R3514	R3516	R3518	R3520
∅ 3.8	R3806	R3808	R3810	R3812	R3814	R3816	R3818	R3820
∅ 4.2	R4206	R4208	R4210	R4212	R4214	R4216		
∅ 4.8	R4806	R4808	R4810	R4812	R4814	R4816		
∅ 5.5	R5506	R5508	R5510	R5512	R5514			
∅ 6.5	R6506	R6508	R6510	R6512				
∅ 7.5	R7506	R7508	R7510	R7512				

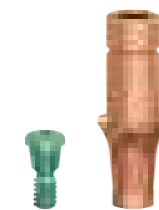

**Get more with every implant!**

Enjoy a complimentary ZBL abutment & Cover Screw with each implant



## Healing Abutment: Nurturing Bone Growth and Aesthetics

Healing abutment support bone growth while preventing tissue collapse around dental implants. It maintains crestal bone integrity, supporting long-term stability.

- Promotes Crestal Bone Growth
- Prevents Tissue Collapse
- Enhances Esthetics

**Discover the difference in implant dentistry!**

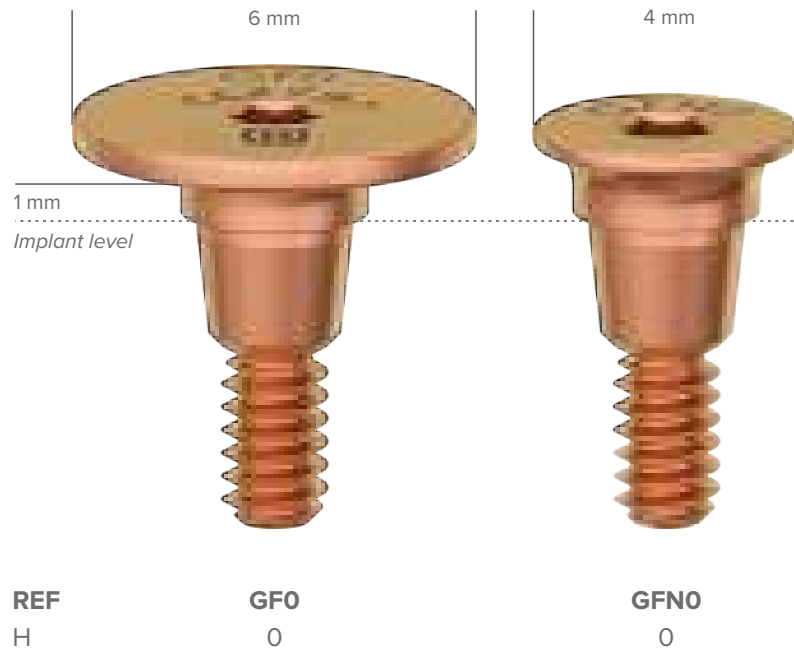

H – Gingiva height, mm

# Healing Abutment Optimal Implant Care

Healing abutment offer unique features that contribute to optimal implant outcomes:

- Ergonomic profile: shapes gum contours naturally
- Two-component design: minimizes force transmission
- Easy removal: threaded interior and removal tool
- Seal conical connection: prevents leakage during healing

**ROOTT R healing abutments elevate implant care with precision and innovation**

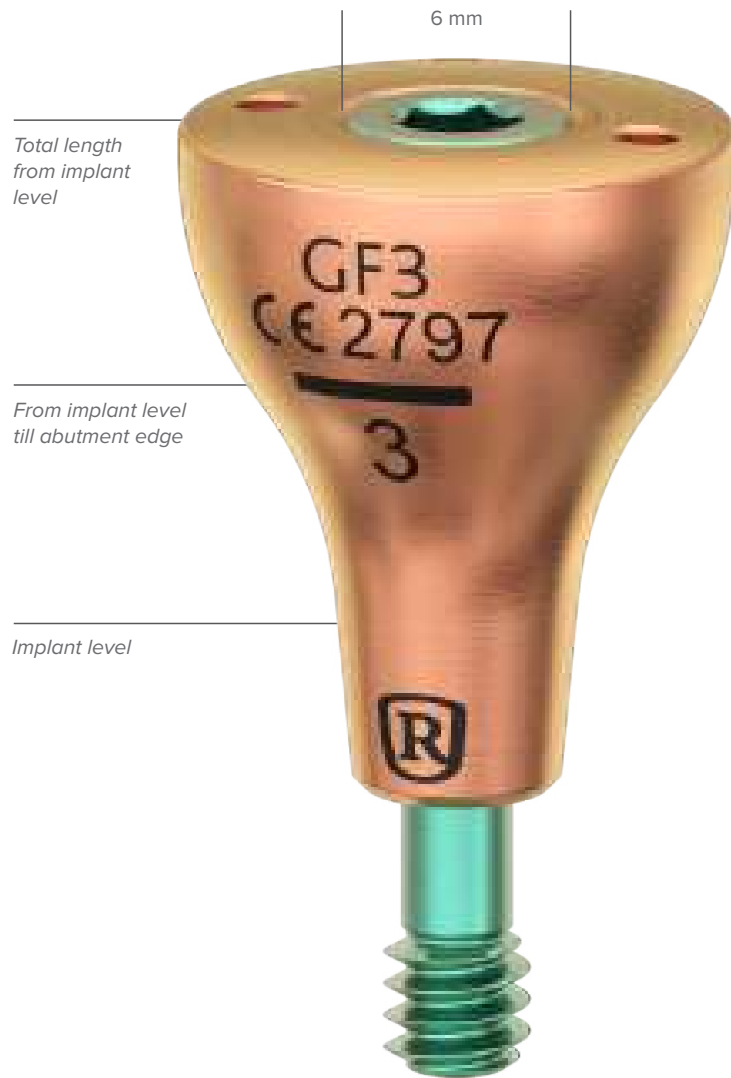

L – Height from implant level, mm  
H – Gingiva height, mm

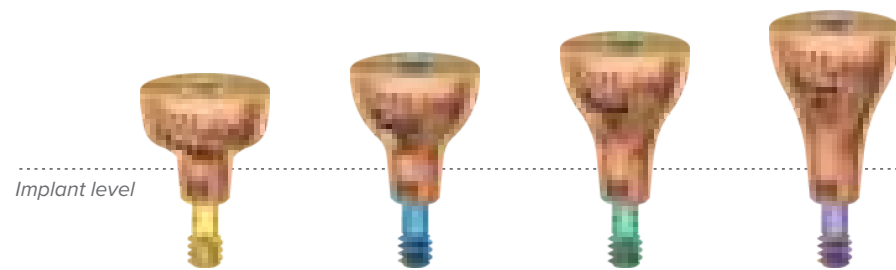

REF	GF1	GF2	GF3	GF4
L	3.5	4.5	5.5	6.5
H	1	2	3	4



## Healing abutment Comprehensive Tissue Tool

A slim healing abutment serves as a crucial intermediate step prior to the application of an anatomical healing abutment, which facilitates the creation of space necessary for soft tissue augmentation.

- **Space for Tissue Augmentation**

The slim design ensures there is enough space for soft tissue grafts, which is crucial for long-term esthetic and functional success.

- **Enhanced Aesthetics**

Healing abutment allows for the placement of a thick connective tissue graft in the most coronal position, improving the papillae and the overall esthetic outcome.

- **Long-Term Stability**

The approach aims to prevent hard and soft tissue resorption, ensuring stable clinical results for many years, which is especially important in the esthetic zone.

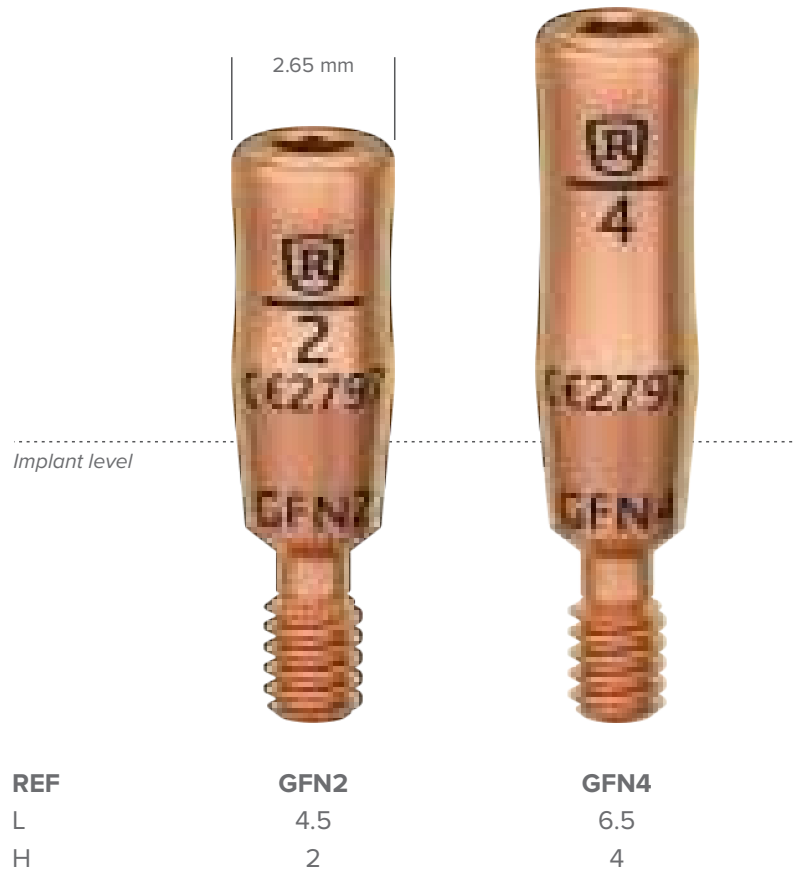

L – Height from implant level, mm  
H – Gingiva height, mm

## Healing Abutment: Elevating Implant Care

Healing abutment is a single-component solution designed for cases where additional load is expected, and passive abutments are preferred.

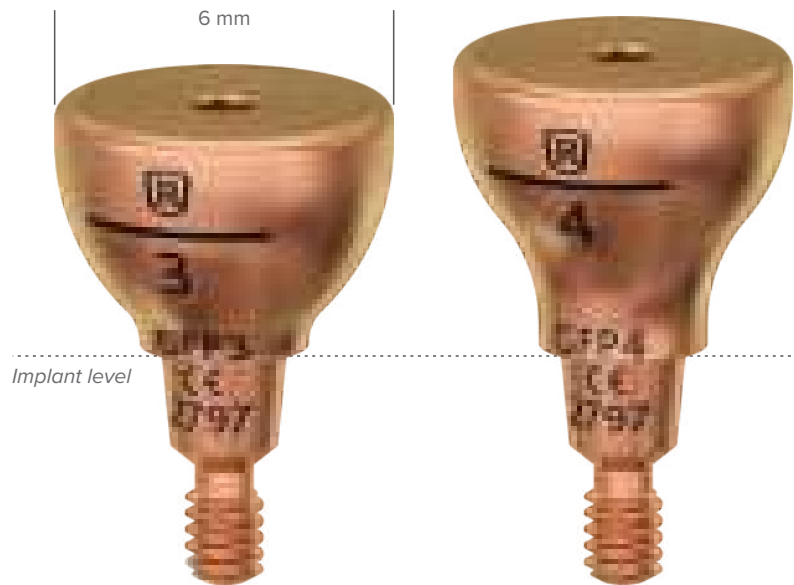

REF	GFP3	GFP4
L	5.5	6.5
H	3	4

L – Height from implant level, mm  
H – Gingiva height, mm

- **Passive Fit**

The abutment fits externally with a cone-shaped interface, ensuring a passive fit.

- **Bone Preservation**

By preventing bone growth on the implant shoulder, abutment maintains crestal bone integrity.

- **Ergonomic Profile**

The abutment's natural shape supports gum contouring for optimal esthetics.

**Experience precision and innovation in implant care with ROOTT R healing abutments.**



## TransferScan® – convenience in impression, precision in scanning

The TransferScan® offers a unique combination of conventional transfer design with a specially treated surface. Whether used for intraoral scanning or laboratory scanning, it ensures precise data capture.

- **Accurate Scanning**

The TransferScan® design allows for precise digital impressions, minimizing distortion and ensuring accurate implant positioning

- **Efficient Workflow**

Whether in the dental office or lab, the TransferScan® streamlines the scanning process, saving time and enhancing productivity

- **Compatibility**

It seamlessly integrates with digital workflows, making it suitable for both chairside and laboratory procedures

**Discover the TransferScan® advantage for reliable implant restorations!**

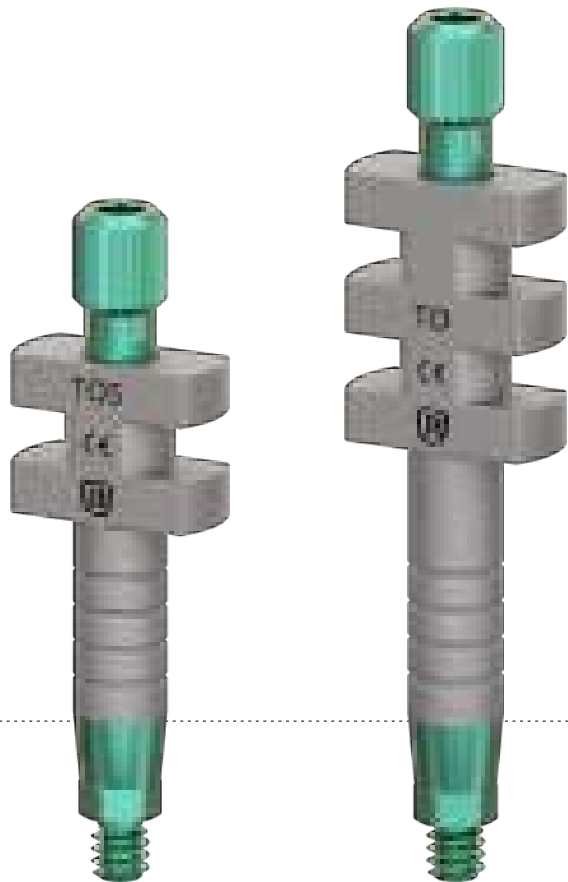

REF  
L

TOS  
10

TO  
15



L – Height from implant level, mm

## Closed-Tray Impression Post

Specifically designed for closed-tray impressions on ROOTT R Implants. Unlike open-tray techniques, closed-tray impressions do not require additional preparation of the impression tray (such as windows or perforations).

- **Snap-and-Go**

The Impression Cap, equipped with a click plastic part, easily snaps into place on the impression post. This secure fit simplifies the impression-taking process and can be used in most cases.

- **Single-Use Assurance**

To ensure optimal fit and precise impressions for each patient, these non-sterile impression posts are intended for single use only. A spare cap is provided in case of immediate retakes.

- Each closed-tray comes with a single-use transfer cap.

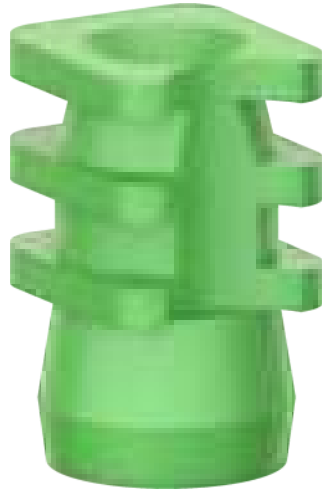

REF TC



REF TR  
L 15

.....  
*Implant level*

L – Height from implant level, mm

## Implant Analogue Bridging Precision and Versatility

Implant analogue, designed as an evolution of the ROOTT R implant system, seamlessly combines two critical components into one. Whether you're working with printed models or following traditional workflows with gypsum casts, the analogue offers unparalleled benefits.

- Use in digital or traditional workflows
- Tapered shape prevents micromovements
- Bottom screw ensures accuracy
- Reverse Scan Analog facilitates accurate analog model creation from digital scans

**Analogue embodies adaptability, precision, and ease of use — a game-changer for implantology**



L – Height from implant level, mm

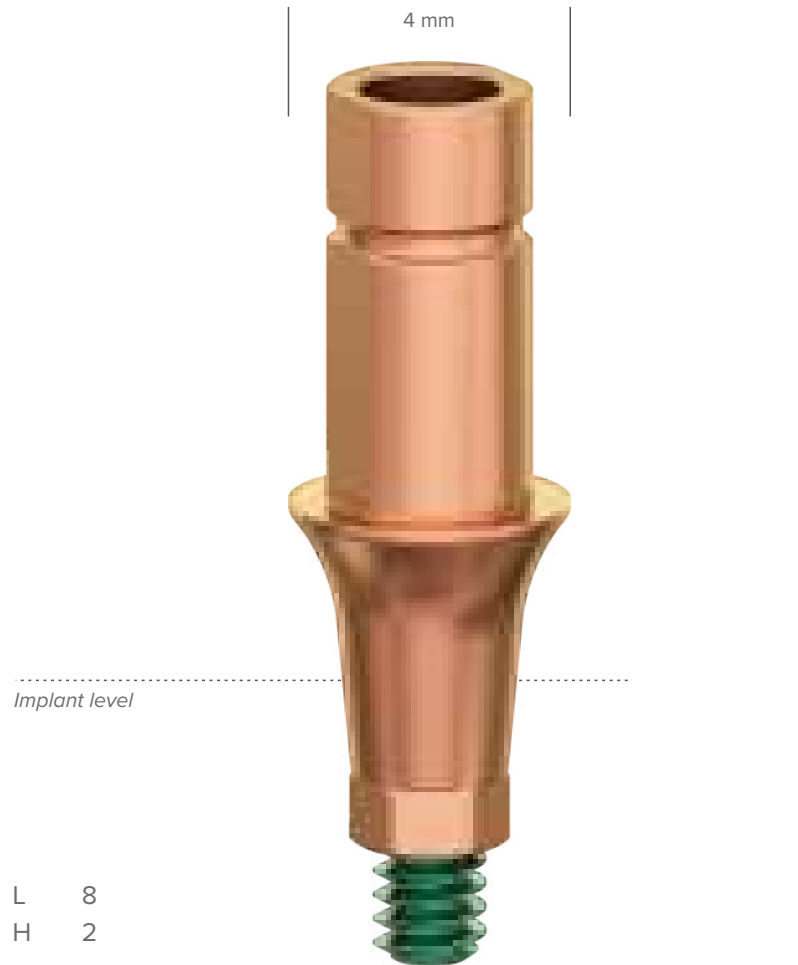

Supplied with screw S8 for clinical use.  
Maximum torque – 15 Ncm.



L – Height from implant level, mm  
H – Gingiva height, mm

## ZeroBoneLoss® abutment ensures the bone level remains unchanged over time and significantly reducing the risk of peri-implantitis

- **Optimized Soft Tissue Integration**

These abutments support a minimum of 2 mm vertical soft tissue thickness, which as described in literature is necessary to avoid bone loss and promote healthy biological width around the implant.

- **Microgap and Platform Switching Technology**

ZeroBoneLoss® abutments utilize precise implant-abutment 5 degree conical connections and platform switching to help improve aesthetic outcome, minimize micromovement, and prevent crestal bone loss.

- **Evidence-Based Protocols**

ZeroBoneLoss® abutments are backed Zero bone loss concept that address both surgical and prosthetic factors, offering predictable and reproducible outcomes for clinicians.

**Viper Edition offers complimentary ZBL abutments redefining implant abutments, aesthetics, and digital workflow integration**

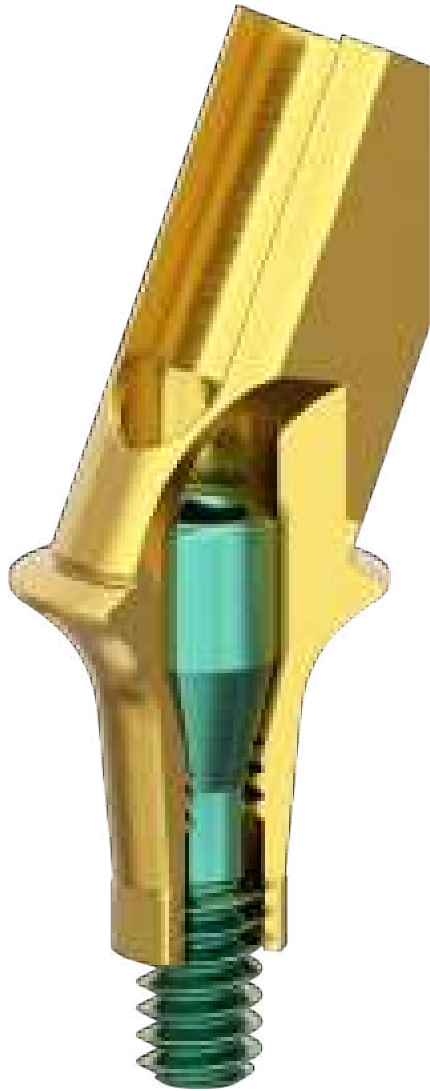

## Anatomical Ti-Base abutment

The Viper Edition abutment seamlessly marries anatomical design with cutting-edge titanium-base technology, redefining implant dentistry.

- Anatomically shaped for optimal soft tissue contours and natural aesthetics.
- Prioritizes gingival harmony, even for short gingival heights
- New conical screw design and thicker walls make it stronger
- Versatile workflow with double antirotational cuts and CAD-CAM-friendly shape

**Viper Edition of anatomical abutments is a game-changer — delivering strength, aesthetics, and adaptability in one remarkable package**



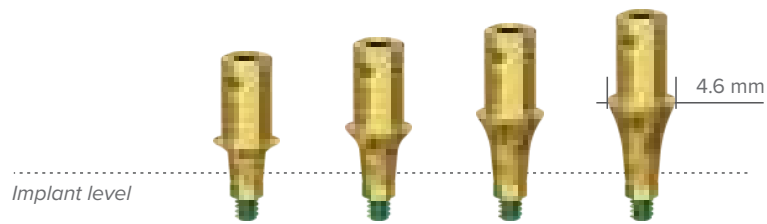

REF	A1	A2	A3	A4
L	7	8	9	10
H	1	2	3	4
Angle, °	0	0	0	0

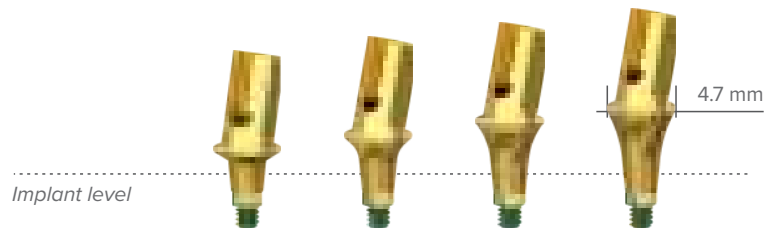

REF	A1A15	A2A15	A3A15	A4A15
L	8	9	10	11
H	1	2	3	4
Angle, °	15	15	15	15

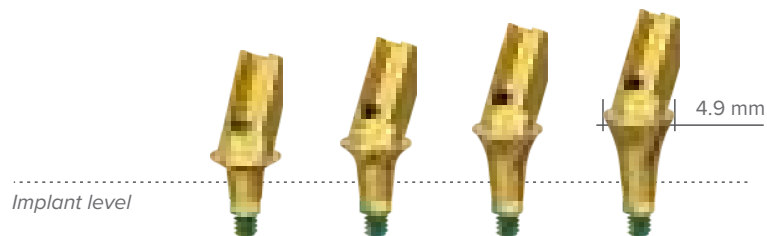

REF	A1A25	A2A25	A3A25	A4A25
L	8.5	9	10	11
H	1	2	3	4
Angle, °	25	25	25	25

### ● Enhanced Prosthetic Workflow

Streamlines restorative processes for single to complex cases. Adapts to digital workflow of 3D printing, CAD/CAM as well as traditional workflows.

### ● Unlock Restorative Possibilities

Compatible with diverse materials and indications. Flexibility for bridges and bars with various implant restorative options.

### ● Titanium Reliability

Anodized surface, high-quality, high Strength Grade 23, biocompatible base for lasting restorations.

### ● Patient-Focused Solutions

Focused on meeting each person's needs.

**Achieve Aesthetic & Functional Excellence:  
Features for optimized aesthetics and emergence**

L – Height from implant level, mm  
H – Gingiva height, mm



## Titanium Bases (Digital Abutments) – The Foundation for Precision Restorations

Engineered for a secure and versatile connection between the implant fixture and the final prosthesis. Our titanium bases, also known as digital abutments, are meticulously crafted to optimize prosthetic workflows and deliver exceptional results.

- **Enhanced Prosthetic Grip**

The precisely blasted surface provides superior retention for both cemented and screw-retained restorations, ensuring a stable and long-lasting connection of crowns and bridges.

- **Angled Screw Access for Optimal Aesthetics**

Featuring an innovative lateral screw channel with up to 20° angulation, these bases allow for convenient screw access without compromising the aesthetic outcome, particularly crucial in anterior cases. This enables clinicians to achieve ideal emergence profiles and natural-looking restorations.



## Titanium bases with Angulated Screw Channel

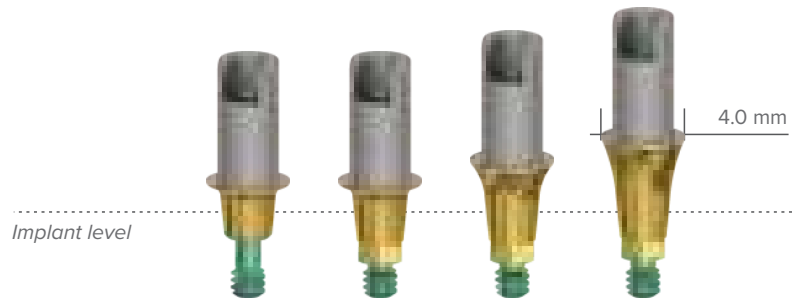

REF	PCOR	PCO1	PCO2	PCO3
L	7	7	8	9
H	1	1	2	3
Index	-	+	+	+

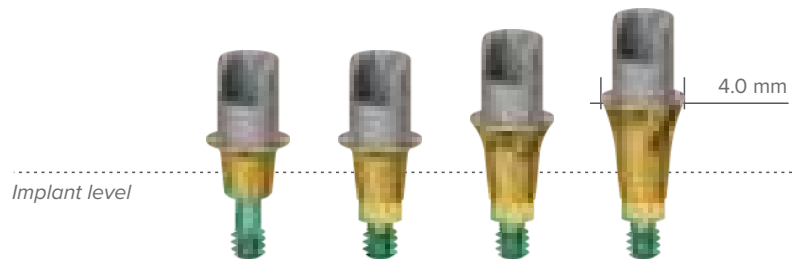

REF	PCORS	PCO1S	PCO2S	PCO3S
L	5	5	6	7
H	1	1	2	3
Index	-	+	+	+

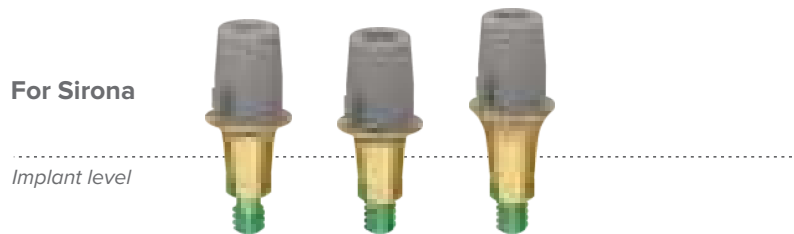

REF	PCO	ATR1	ATR2
L	7.0	5.7	6.2
H	2.5	1	1.5

- Reliable and predictable prosthetic workflows
- Enhanced retention and stability of final restorations
- Improved aesthetic outcomes with angled screw access
- High-quality titanium construction for biocompatibility and durability

**Elevate your implant restorations with the precision and versatility of our titanium bases!**

L – Height from implant level, mm

H – Gingiva height, mm

## ROOTT R Multi-Unit Abutments – Versatile Solutions for Complex Implant Restorations

Platform-specific connectors designed to simplify and enhance the creation of multiple-unit prostheses (single crowns, bridges, overdentures) on dental implants. ROOTT R Multi-Unit Abutments offer exceptional versatility and strength for predictable and long-lasting results.

- **Unmatched Restorative Versatility**

These abutments are engineered to accommodate a wide range of prosthetic options, including screw-retained, cement-retained, and attachment-retained restorations, providing flexibility for diverse clinical needs.

- **Significant Angulation Correction**

With the ability to compensate for implant angulation discrepancies up to 75°, ROOTT R Multi-Unit Abutments ensure optimal prosthetic alignment, even in challenging implant placements, leading to improved aesthetics and function.

- **Secure and Durable Fixation**

Featuring a strong 1.8 mm screw, these abutments guarantee secure retention of the prosthetic superstructure, minimizing the risk of loosening and ensuring long-term stability and patient satisfaction.



SFM6 SLFM6



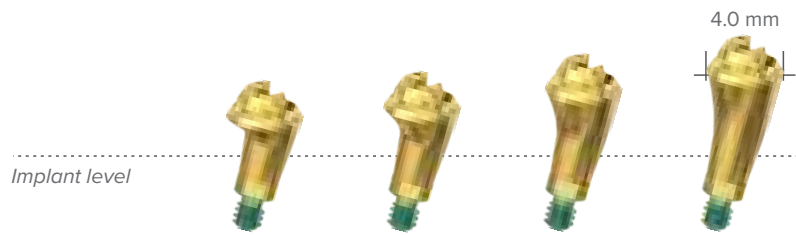

REF	M1A15	M2A15	M3A15	M4A15
L	3.3	3.8	4.8	5.8
H	1	2	3	4
Angle, °	15	15	15	15

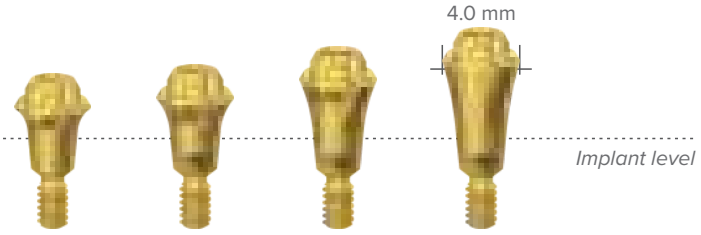

REF	M1	M2	M3	M4
L	2.9	3.4	4.4	5.4
H	1	2	3	4
Angle, °	0	0	0	0

For M1-M4 abutments  
placement ITMx implant  
driver is required

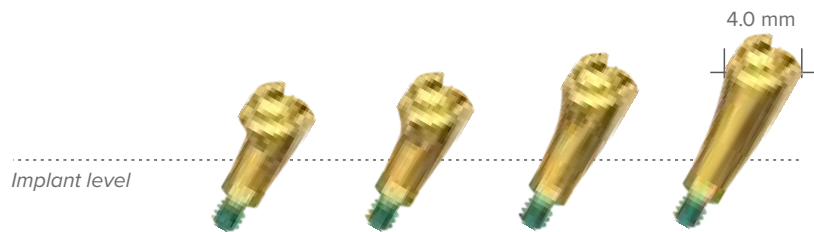

REF	M1A30	M2A30	M3A30	M4A30
L	3.8	4.3	5.5	6.6
H	1	2	3	4
Angle, °	30	30	30	30

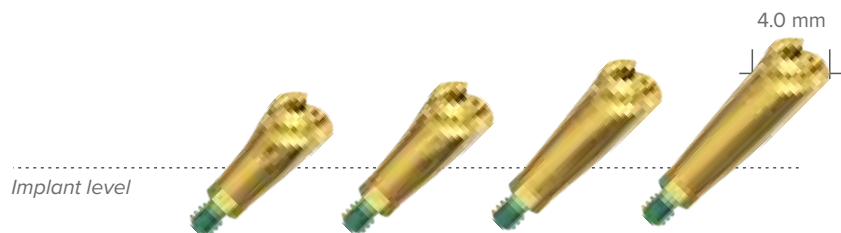

REF	M1A45	M2A45	M3A45	M4A45
L	4.7	5.4	6.9	8.3
H	1	2	3	4
Angle, °	45	45	45	45

- Flexibility in planning and executing complex restorations
- Effective correction of implant angulation for optimal outcome
- Reliable and durable connections for long-term success
- A streamlined workflow for multiple-unit restorations

**Experience the strength, versatility, and efficiency of ROOTT R Multi-Unit Abutments for predictable and successful implant-supported restorations!**

L – Height from implant level, mm

H – Gingiva height, mm



## ROOTT R Attachment-Retained Abutments: Empowering Stability and Comfort in Overdentures

The definitive solution for secure, comfortable, and long-lasting attachment-retained restorations. ROOTT R Abutments are meticulously engineered to provide exceptional stability and ease of use for both clinicians and patients.

- **Unwavering Secure Retention**

Optimal grip provides confidence and security for denture wearers.

- **Simplified Maintenance & Adjustments**

Self-aligning design for easy insertion, removal, and maintenance.

- **Enhanced Patient Comfort & Natural Feel**

Resilient nylon inserts absorb forces and minimize wear.

- **Superior Long-Term Durability**

TiN coating enhances wear resistance for lasting reliability.

**Choose ROOTT R Attachment-Retained Abutments for predictable outcomes and happy, confident patients!**

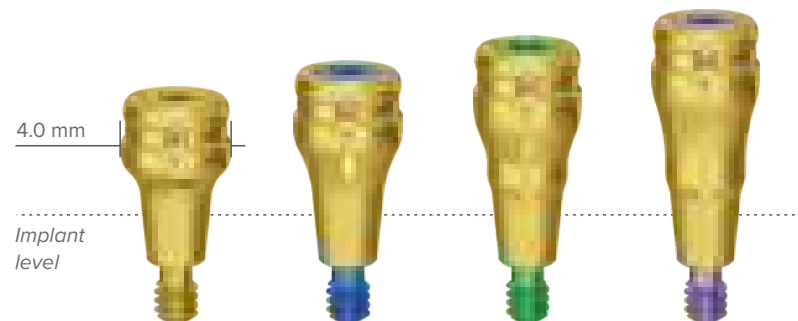

REF	B1	B2	B3	B4
L	4.3	5.2	6.2	7.2
H	1	2	3	4



REF	BCW	BCP	BCY	HBC
	Retention insert, standart, 1800g	Retention insert, soft, 1200g	Retention insert, extra soft, 600g	Matrix housing

L – Height from implant level, mm  
H – Gingiva height, mm

● **Ultra-Compact Design**

The smallest attachment system, with height options to choose from and small diameter, ideal for limited inter-arch space.

● **Flexible Retention**

Offers different inserts with three retention levels for personalized stability and easy chairside/lab adjustments.

● **Passive Fit Innovation**

Pivoting mechanism and rotational core allows passive insertion with up to 40° implant divergence.

● **Premium Engineering**

Durable titanium housing with TiN coating and stainless-steel core for biocompatibility and longevity.

**Elevate your restorative practice and patient satisfaction with ROOTT R Attachment-Retained Abutments!**



## Telescopic Abutment: The Future of Cementless Implant Restorations

Experience a revolutionary approach to implant-supported restorations with Telescopic Abutments. Embrace a simplified, cementless workflow that prioritizes precision and stability.

- **Unmatched Frictional Retention**

Utilizing a known cone-in-cone connection, abutments achieve secure and reliable retention of implant-supported copings without the need for screws or cement, eliminating potential complications associated with these traditional methods.

- **Significantly Streamlined Workflow**

Conometric technology minimizes the need for complex modifications and procedures, simplifying the restorative process, ensuring ease of use, and promoting predictable, efficient outcomes.

- **Functional Stability with Uncompromising Simplicity**

Telescopic Abutments deliver exceptional functional stability for the final restoration while maintaining an inherently simple and user-friendly design, representing a true advancement in implant dentistry.

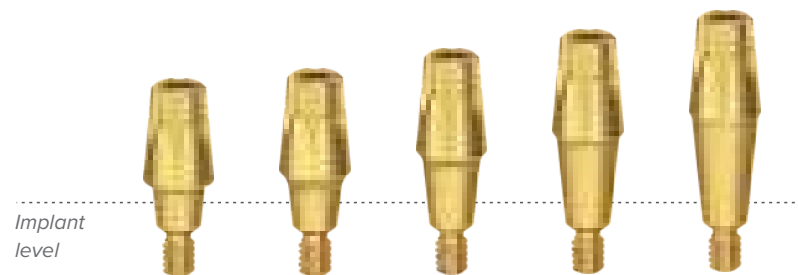

REF	A05K	A1K	A2K	A3K	A4K
L	6	6.5	7.5	8.5	9.5
H	0.5	1	2	3	4
Angle, °	0	0	0	0	0

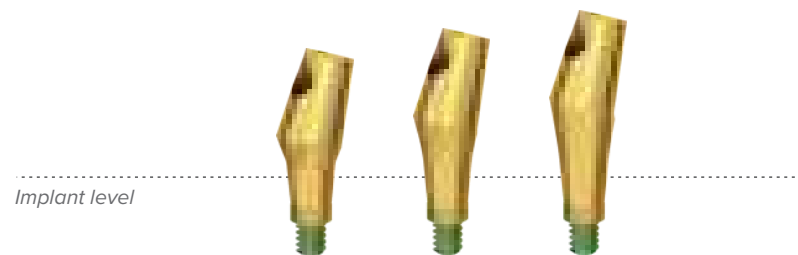

REF	A1A15K	A2A15K	A3A15K
L	6.9	7.9	8.9
H	1.5	2	3
Angle, °	15	15	15

**Abutments for telescopic fixation**



REF	TCK0	TCK1	TCK2	TCK3
Full height, mm	6.3	6.3	6.3	6.3
H	0	1	2	3

● **Healthier Peri-Implant Tissues**

No cement, no risk of residual cement, a major contributor to peri-implantitis.

● **Streamlined Workflow**

Offers a simpler and more efficient prosthetic process for clinicians.

● **Secure & Stable Connections**

Achieves reliable retention through innovative friction-fit or screw-retained designs without any cementation.

● **Digital Dentistry Compatible**

Integrates seamlessly with digital workflows and modern materials.

● **Versatile Applications**

Supports a range of prosthetic treatment options from single-tooth and multi-unit restorations.

L – Height from implant level, mm

H – Gingiva height, mm

# Introducing ROOTT R Premilled Blanks: The Foundation for Exquisite Custom Abutments

Elevate your restorative practice with ROOTT R Premilled Blanks, the cornerstone for creating highly precise and patient-specific custom abutments.

- **Uncompromising Fit**

High-grade titanium alloy blanks with pre-machined, ultra-precise implant connections.

- **Esthetic & Comfortable**

Ideal for creating custom abutments that perfectly match natural gum lines.

- **Simplified Care**

Enables easier cleaning and adjustments for long-term patient satisfaction.

- **Healthier Outcomes**

Minimizes micro-movements and wear, improving peri-implant health.

**Unlock the potential for truly personalized and exceptional implant restorations with ROOTT R Premilled Blanks**



REF

PMAB

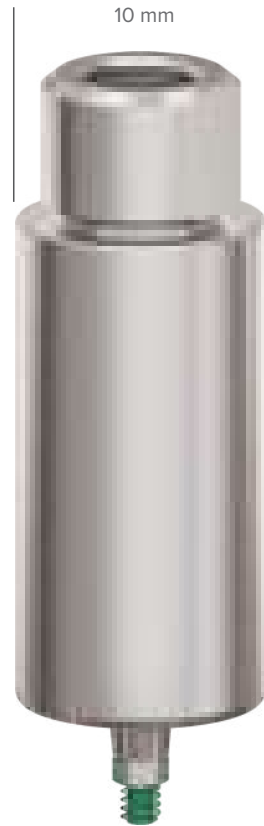

PMAB-A



Supplied with two screws:  
for laboratory use (pink)  
for clinical use (green)

Maximum torque – 15 Ncm





## ROOTT R Surgical Cassette: Organized Efficiency

ROOTT R Surgical Cassette is a specialized container meticulously crafted to securely hold various dental instruments within a dental implant instrument kit for ROOTT R implant placement. Featuring compartments and slots, this cassette organizes instruments, ensuring quick access during procedures. ROOTT R Surgical Cassette maintains order, allowing clinicians to focus on patient care.

**Elevate your implant practice with ROOTT R Surgical Cassette — precision, convenience, and seamless workflow!**

REF TRR

Instruments not included



## ROOTT R Implant Drills: Engineered for Precision, Built for Durability

Experience the ultimate in drilling efficiency and control with ROOTT R Implant Drills, versatile instruments designed for both precise bone removal and effective osseodensification.

- **Dual-Mode Efficiency**

Clockwise cutting & counterclockwise osseodensification for optimal bone management.

- **Implant-Specific Design**

Customized shapes ensure perfect torque transfer in one step.

- **Superior Strength**

Medical stainless steel with, wear, and corrosion resistance.

- **Enhanced Surgical Guidance & Safety**

Cylindrical upper portion for precise guided surgery and collision prevention. This feature also facilitates precise bone cutting while effectively preventing collisions with healing abutments.

**Achieve predictable and successful implant procedures with the precision, resilience, and efficiency of ROOTT R Implant Drills**

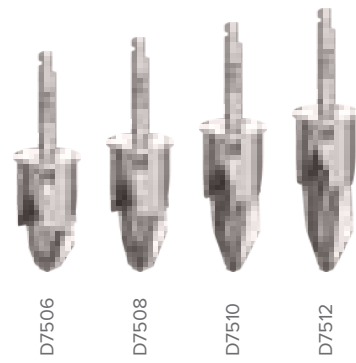
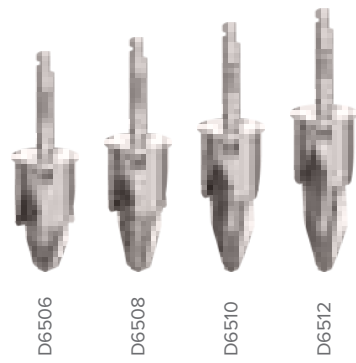
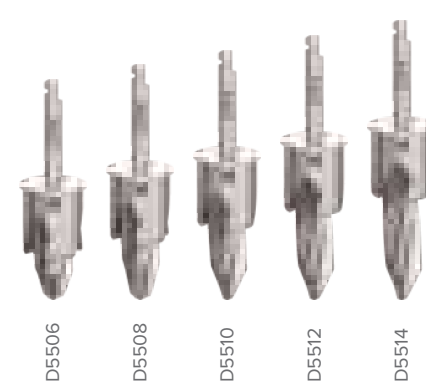
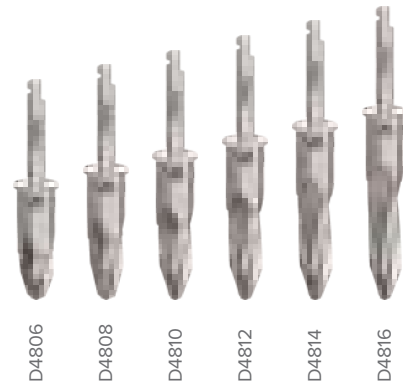
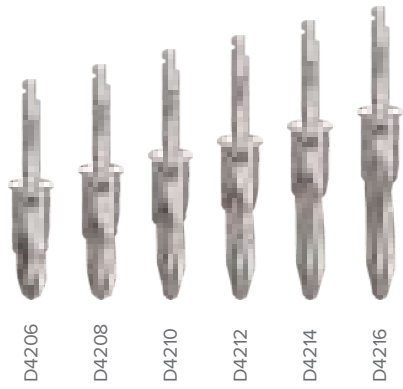
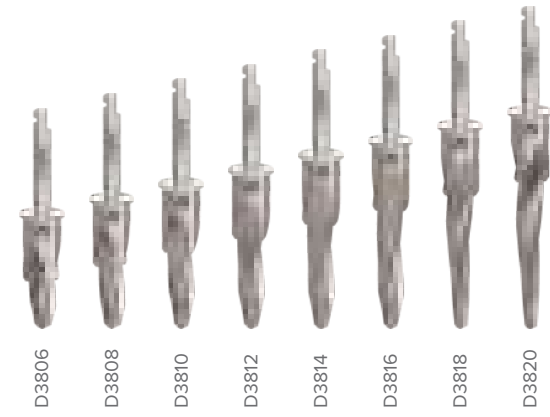
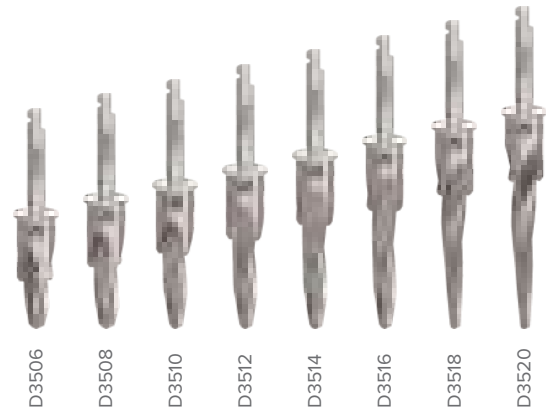
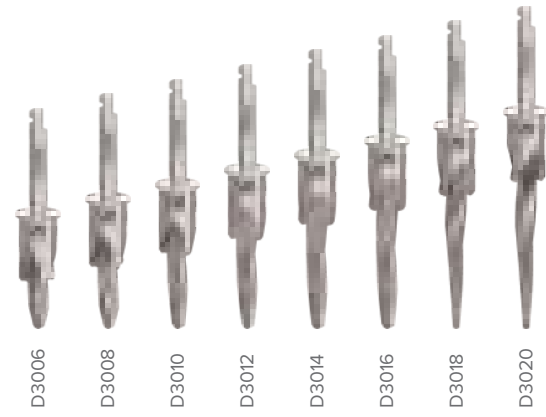

## ROOTT R Implant Drivers: Precision Guidance for Optimal Implant Placement

Essential tools for accurate and controlled dental implant insertion, compatible with various driving methods for seamless integration into your surgical workflow.

- **Universal Compatibility**

Works like a part of guided system or can be used in manual insertion.

- **Secure "Sticky" Grip**

Unique internal connection for reliable implant holding and reduced slippage.

- **Integrated Depth Guide**

Clear markings for accurate and predictable implant placement.

- **Easy Orientation**

Hex side positioning marks for simple and correct implant alignment.

**Achieve accurate and efficient implant placement with the precision and reliability of ROOTT R Implant Drivers, leading to greater confidence and successful outcomes**



## ROOTT R Abutment Extractors: Gentle Power for Abutment Removal

Specialized dental instruments engineered for the safe and efficient removal of implant abutments, even those that are cold-welded or conically engaged.

- **Safe and Controlled Extraction**

ROOTT R Abutment Extractors are designed to securely lift abutments with controlled force, minimizing stress on the implant fixture and surrounding bone structure during the removal process.

- **Preserves Implant Integrity & Patient Comfort**

Clinicians can confidently remove abutments without compromising the integrity of the implant, ensuring patient comfort.

**Ensure a smooth and safe workflow for abutment removal with the precision and efficiency of ROOTT R Abutment Extractors**



**REF**

Working part, mm

**SR**

19

**SRL**

26



# ROOTT **M**

## One-piece tissue-level implants designed for Minimal invasive Surgical Approach & Versatile Restorations

- **Multi-unit Connection**

Single-unit design screw-retained adapts to titanium bases. Up to 60° divergence/convergence for complex cases.

- **Versatile Thread Design**

Easy, predictable placement in atrophic thin ridges, sockets, nasal area ideal for immediate loading.





































- **Anodised Cervical collar**

Respects the Biologic width promotes stability of hard and soft tissues.

- **Compatibility & Screw-Retained**

Designed for reliable, secure, fully screw-retained restorations and in Synergy with ROOTT R multi unit abutments and ROOTT P implants for comprehensive solutions.

**Experience the efficiency and versatility of ROOTT M Implants for predictable and successful implant-supported restorations**

	4 mm	6 mm	8 mm	10 mm	12 mm	14 mm	16 mm	18 mm	20 mm
ø 2.5			 C2508m	 C2510m	 C2512m	 C2514m	 C2516m		
ø 3.0			 C3008m	 C3010m	 C3012m	 C3014m	 C3016m	 C3018m	 C3020m
ø 3.5		 C3506m	 C3508m	 C3510m	 C3512m	 C3514m	 C3516m	 C3518m	 C3520m
ø 4.0	 C4004m	 C4006m	 C4008m	 C4010m	 C4012m	 C4014m	 C4016m		
ø 5.0	 C5004m	 C5006m	 C5008m	 C5010m	 C5012m	 C5014m			
ø 6.0	 C6004m	 C6006m	 C6008m	 C6010m	 C6012m				



# ROOTT **P**

## ROOTT P Pterygoid Implants: Your Solution for the Severe Atrophic Posterior Maxilla

Empower your practice with ROOTT P, the advanced pterygoid implant system designed for minimally invasive and predictable restoration of the challenging atrophic posterior maxilla.

- **Eliminate Complex Augmentation**

ROOTT P offers a minimally invasive alternative to sinus lifts, bone grafting, and zygomatic implants, specifically engineered to anchor in the dense pterygoid bone for predictable results in severe bone loss.

- **Immediate Functionality**

Providing flexibility for both immediate and delayed loading, ROOTT P allows for faster restoration of function and aesthetics, potentially offering patients fixed teeth in a single visit and reducing overall treatment time.

- **Exceptional Stability in Compromised Bone**

Optimized for cortical engagement, ROOTT P achieves high primary stability even in atrophic bone, ensuring secure anchorage and long-term success without the need for cantilever bridges.

- **Versatile Prosthetic Options & Simplified Workflow**

Compatible with a wide range of prosthetic options and featuring a streamlined, Digital workflow and minimal invasive surgery with ultra-sharp drills, ROOTT P simplifies protocols and reduces chair time.

**ROOTT P: Deliver fast, reliable, and minimally invasive solutions for complex maxillary cases, restoring patient smiles with confidence and efficiency**



## ROOTT Multi-Unit Healing Abutments

- **Compatible with all ROOTT line**

Available for all multi-unit abutments platform of different angulations of ROOTT R (0°, 15°, 30°, 45°) and ROOTT M, P lines.

- **Improved Esthetics**

By supporting the natural tissue contours of the patient, GFM help achieve better esthetic outcomes, ensuring a more natural and harmonious appearance.

- **OA-OT and Soft Tissue Seal Protection**

The use of GFM protects peri-implant soft tissues from damage caused by repeated screwing and unscrewing during prosthetic procedures, as all manipulations occur above the MUA platform at the level of the free gingival margin, providing One Abutment – One Time Concept.

- **Ease of Prosthesis Management**

GFM simplify the seating and removal of the final restoration, making maintenance and adjustments easier and more predictable for clinicians.

- **Versatility**

GFM come in various collar heights enabling clinicians to customize treatment to individual patient needs, use during conventional healing phase when immediate loading is not possible.

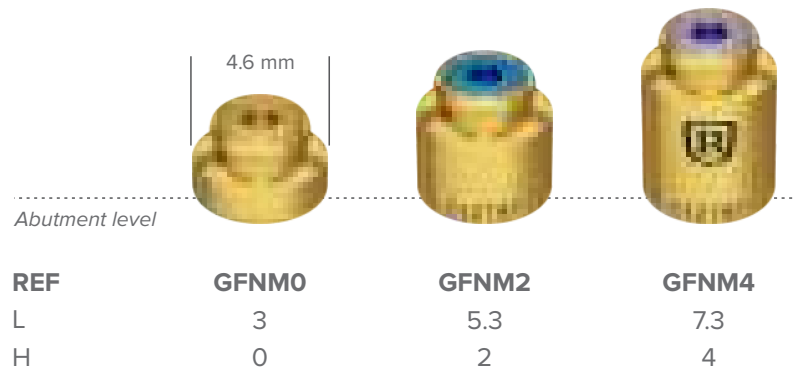
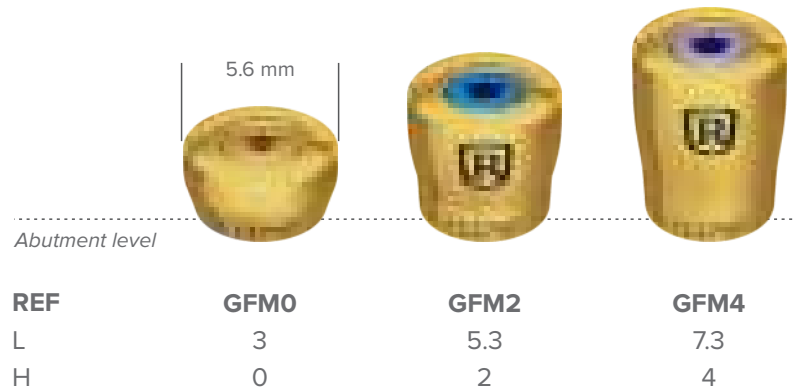

L – Height from abutment level, mm

H – Gingiva height, mm

## The ROOTT M/P Foundation for Secure Locator Overdentures

Introducing the ROOTT GFNM abutment – while promoting optimal soft tissue health, its primary focus is to provide a precise and reliable platform for secure overdenture anchorage on these ROOTT M/P implants.

- **Predictable Outcomes**

Engineered for precise integration, leading to predictable overdenture retention.

- **Efficient Workflow**

Direct connection simplifies the prosthetic process, saving chair time.

- **Patient Satisfaction**

Enhanced stability and comfort lead to greater patient confidence.

- **ROOTT M System Synergy**

Specifically designed for optimal performance with ROOTT R/M/P implants.

- **Quality and Reliability**

Manufactured to ROOTT's high standards for long-lasting performance.



**Empower your patients with comfortable, functional, and secure removable prosthetic solutions utilizing the streamlined design of ROOTT MUA connection**



## TransferScan® – convenience in impression, precision in scanning

TransferScan®: The 2-in-1 Solution for Open Transfer Accuracy and Efficient Scanning applications on multi-unit.

- **Efficient Workflow**

Streamlines with Digital workflow application with intraoral / laboratory scanning or conventional Impressions techniques.

- **Versatile Compatibility**

Seamlessly integrates with digital workflows across ROOTT R/M/P lines.

- **Durable Material**

High-quality titanium ensures strength and longevity with special surface treatment for precise data capture.

- **Accurate Scanning**

Design feature minimizes distortion for precise scanning of implant positions.

**Discover the TOM/TOML TransferScan® advantage for reliable implant restorations on multi-units**

REF

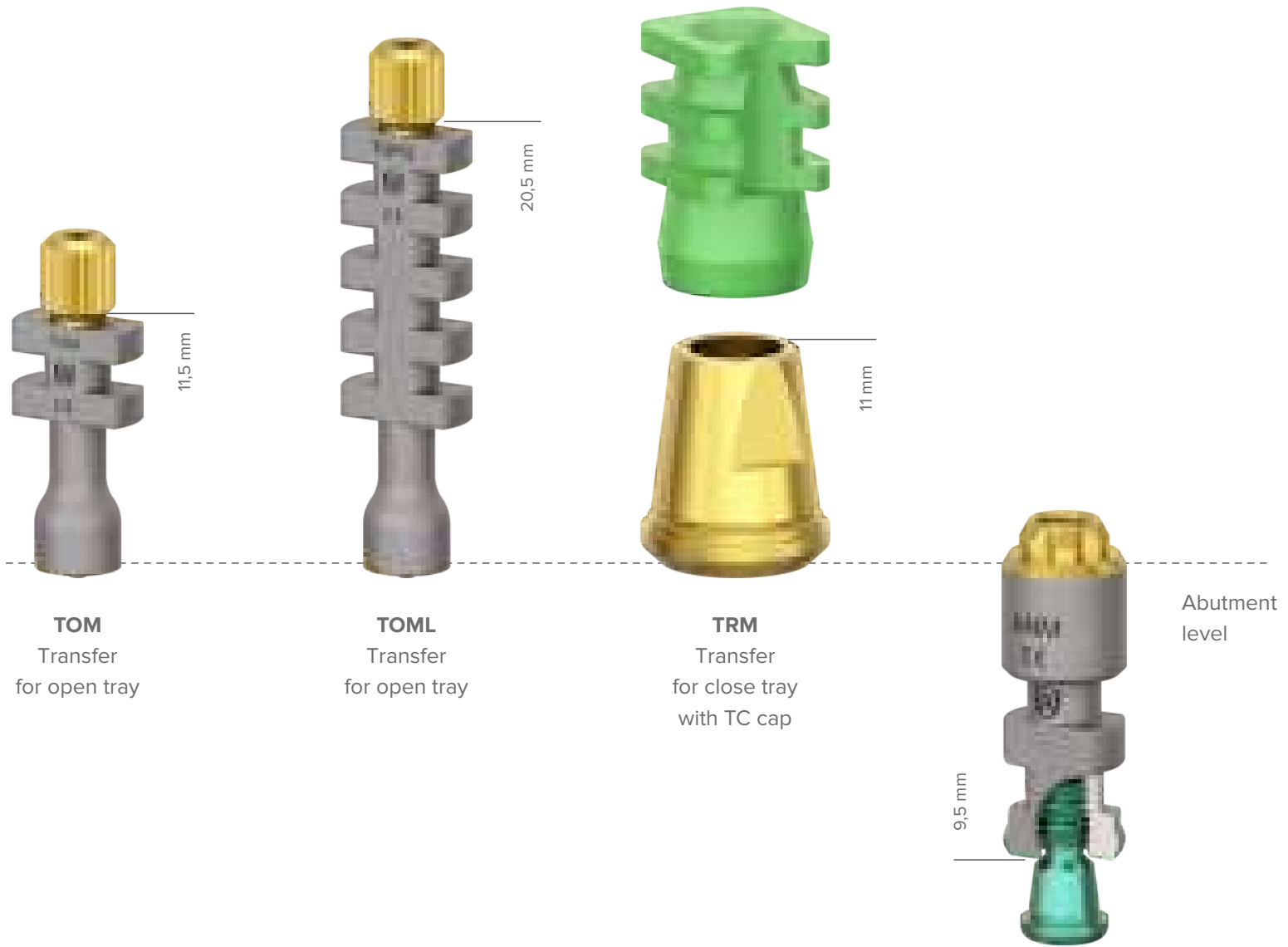

# Dragon Scan Solutions: Capture Precision, Conquer Time in Digital Impressions

Revolutionize your restorative workflow with ROOTT R DragonScan, engineered for unparalleled accuracy and speed.

- **Enhanced Reference Stability in Edentulous Cases**

The SPCOMIO Scan body, when used with Titanium pins, ensures that the reference between implants is not lost during the scanning process, which is particularly crucial in edentulous cases where maintaining positional accuracy across multiple implants can be challenging.

- **Versatile Options**

Titanium pins come in 7.5mm and 15mm heights for optimal configuration.

- **Durable Material**

High-quality titanium ensures strength and longevity.

- **Improved Accuracy**

Secure fixation improves digital impression accuracy for better-fitting prosthetics. Reduces errors, rescans, and chair time.

**Upgrade to Dragon Scan and unlock a new level of speed, precision, and patient satisfaction in your digital impression workflow!**

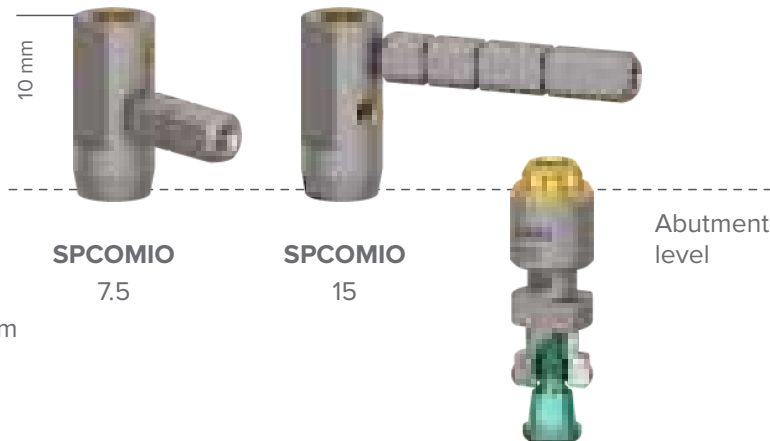

## Laboratory Analog / Reverse Scan for multi-unit



- **Reverse Scan Analog**

Streamlines the process from implant position to final prosthesis, enabling a fully digital workflow. Delivers 100% fit accuracy for prototypes and final prostheses, crucial for long-term success. Reduces patient visits and chair time, while supporting predictable and reliable outcomes.

- **Analog & Digital Compatibility**

Suitable for both traditional and digital impression techniques. Reduces patient visits and chair time, while supporting predictable and reliable outcomes.

- **High Precision Machining**

Ensures accurate transfer of implant position.

- **Reduced Length**

Saves on scanning material during digital workflows.

REF

ANM

## ROOTT M Titanium Bases: The Foundation for Precise and Versatile Multi-Unit Restorations

Essential for modern implant dentistry, ROOTT M titanium bases offer a stable and adaptable interface for diverse prosthetic restorations, particularly excelling in personalized multi-unit cases and providing the precise connection needed for materials like Zirconia, PMMA, and PEEK.

- **Enhanced Stability**

External anti-rotation cuts prevent prosthetic movement for long-term reliability.

- **Simplified Adjustments**

Angled screw access channel allows for easy prosthetic screw adjustments.

- **Optimized Bonding**

Blasted surface and microgrooves enhance adhesion for a strong, durable bond.

- **Secure Retention**

Stronger conical screw prevents loosening, ensuring long-term stability.

**ROOTT M Titanium Bases are the cornerstone for achieving stable, compatible with ROOTT R/M/P lines, and efficient multi-unit implant restorations, empowering clinicians to deliver predictable and long-lasting results for their patients**



REF

PCOM

PCOMR

Ti-base

Rotational Ti-base

L

5.5

5.5



L – Height from abutment level, mm



## Temporary multi-unit Ti-Base

- **Dual Workflow Compatibility**

Can be used in both conventional and digital workflows.

**Conventional:** Suitable for traditional denture construction techniques.

**Digital:** Fully compatible with CAD/CAM and 3D printing for digital prosthetic design.

- **Various Heights Options**

Offers 4 different customized heights, allowing the clinician to select the ideal height for the patient prosthetic needs.

- **Optimized for CAD/CAM Ceramic Restoration**

Designed with features that simplify digital design and milling of ceramic restorations.

- **Precise Geometry**

Ensures a secure fit for milled crowns or bridges.

- **User-Friendly Design**

Simplifies the workflow for both temporary and final prosthesis.

REF

L

AM

11

L – Height from abutment level, mm

## Straight & 15° Angled burn-out abutments



**ABMU**  
Straight  
9



**ABMUA**  
15° Angled  
9

- **Prosthetic Flexibility:** Custom abutments/frameworks for multi and full-arch cases. User-friendly design with reliable burnout.

- **Workflow Integration**  
Compatible with lost-wax casting for non precious metals.

- **Precision & Efficiency**  
Streamlined workflow and cost-effective alternative to custom-milled bases. Accurate fit and consistent casting quality.



**SFPCOM**  
ø 1.8

Prosthetic screw SFPCOM is used for abutments from ROOTT M and ROOTT P product lines and for direct connection between the framework and the implant.

**REF**  
L

L – Height from abutment level, mm



## Innovative TRS Surgical Cassette: Experience Unparalleled Efficiency

Optimize your ROOTT implant procedures with our expertly curated surgical drill kits, now featuring the advanced TRS Surgical Cassette. Designed to enhance workflow and ensure the integrity of your instruments, this system delivers a new level of convenience and confidence to your ROOTT implant practice.

**Invest in the ROOTT Implant Surgical Kit with the TRS Surgical Cassette – the intelligent solution for efficient, safe, and predictable ROOTT implantology**

REF TRS

Instruments not included

## Implant drivers

## Screwdrivers



REF  
H, mm

ITM0  
0

ITM10  
10

ITM  
20

ITML  
40

ITMXL  
60

SD  
7

SDL  
12

SDXL  
41

SDLB  
11

SDXLB  
40

SDH  
10

SDHL  
15

SDHXL  
40

Ball-hex Ball-hex

For ratchet

For handpiece

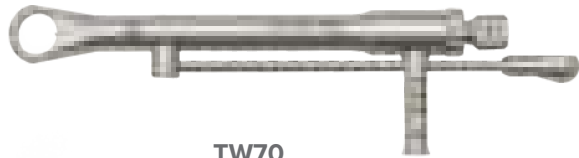

**TW70**  
Torque Wrench



**DW**  
Handle for implant driver



**ETH**  
Surgical handle



## Implant drivers

## Taps



REF  
H, mm

ITE 8  
ITEL 14  
ITEXL 34

ITEH 12  
ITEHL 22

CS2518F CS3018F CS4018F

For ratchet

For handpiece



**TW70**  
Torque Wrench



**DW**  
Handle for implant driver



**ETH**  
Surgical handle

## Drills

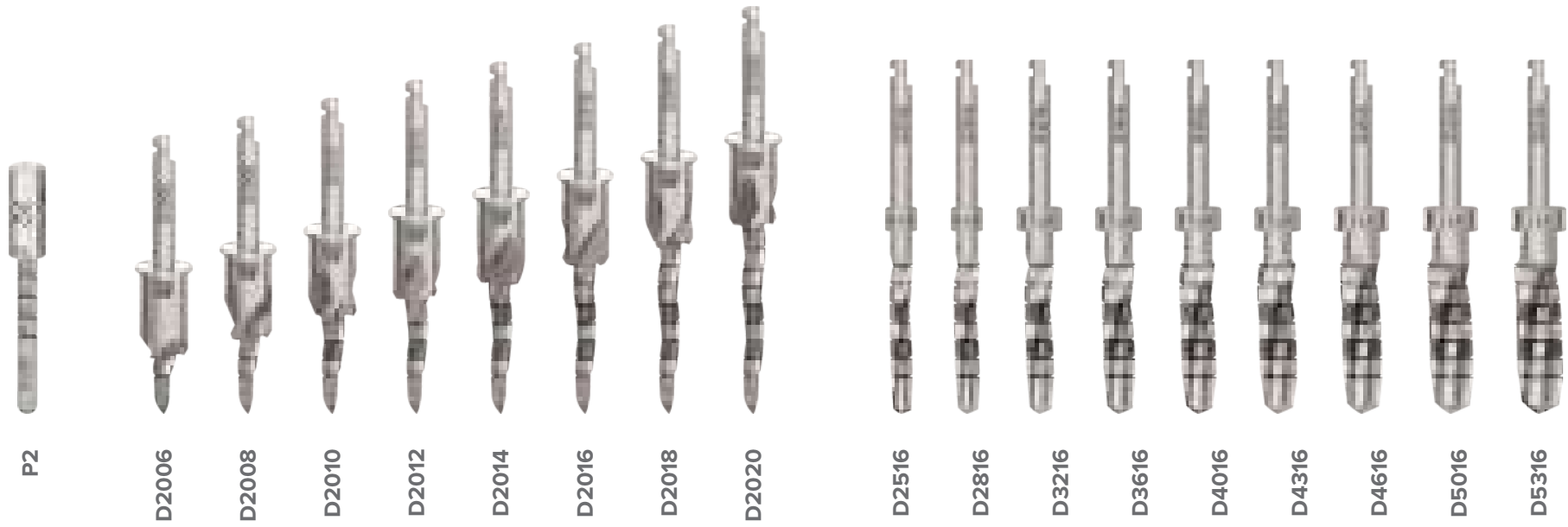

## Stoppers

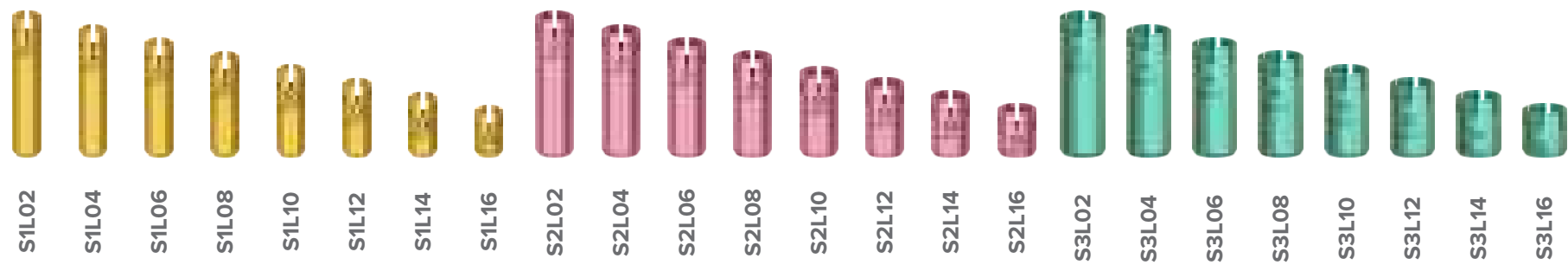



## Upcoming global events 2025/2026

### **EAO 2025**

18-20 September  
Monaco

### **ROOTTERS Summit**

26-27 October  
Bern, Switzerland

### **ADF 2025**

25-29 November  
Paris, France

### **AEEDC 2026**

19-21 January  
Dubai, UAE

### **IDEM 2026**

17-19 April  
Singapore

26-27 OCTOBER



SWITZERLAND

*Rootters*<sup>®</sup>

# 14<sup>TH</sup> ANNIVERSARY SUMMIT

Join us in the stunning town of Bern, Switzerland  
to celebrate our 14<sup>th</sup> anniversary in Europe,  
with cutting-edge insights and unforgettable experiences!

# Make Your Surgery Guided

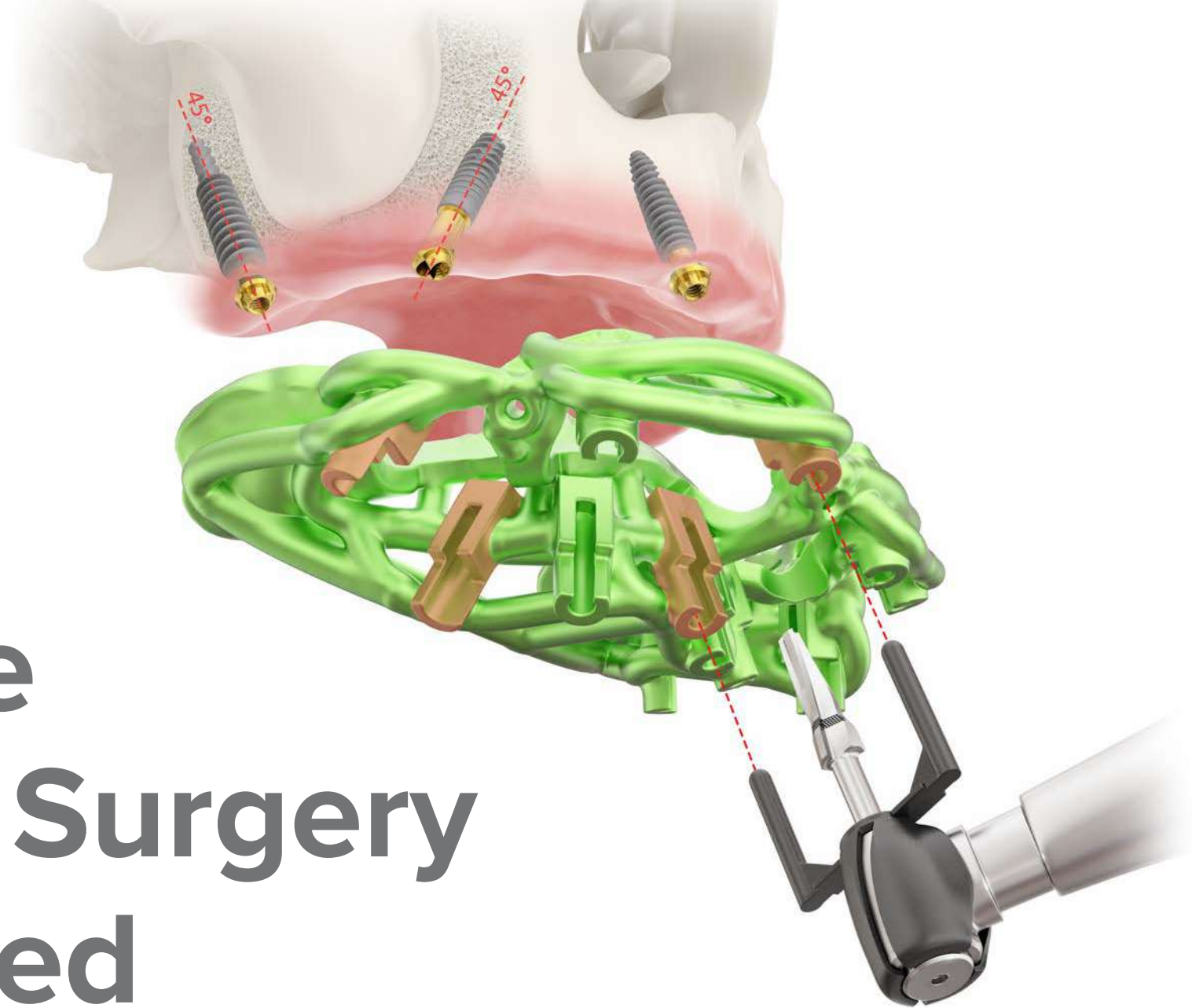

# 80+ COUNTRIES

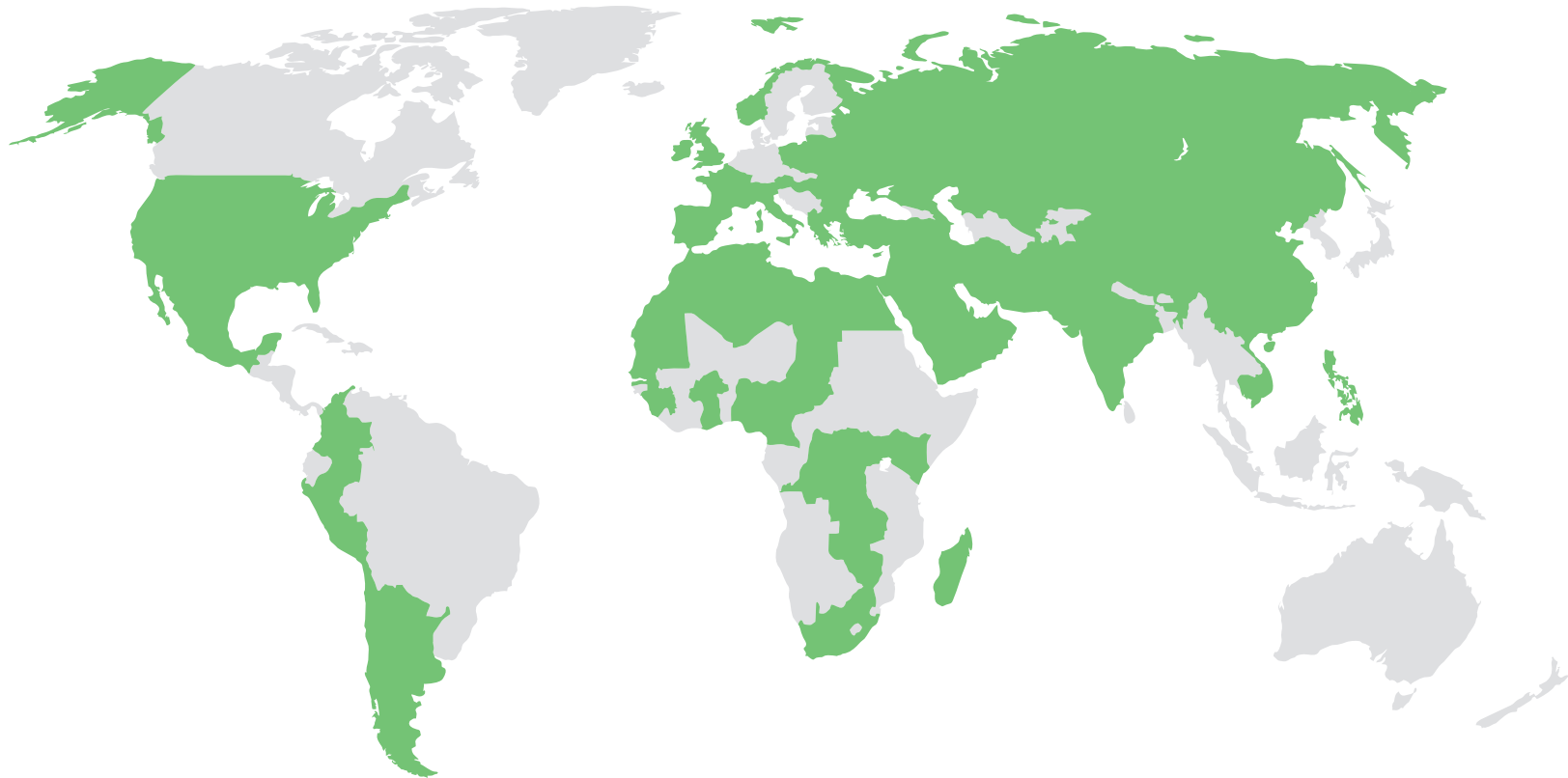

 ROOTT AG  
Bahnhofstrasse 16  
6037 Root  
Switzerland

 ROOTT UAB  
Kauno m. sav. Kauno m.  
Jonavos g 254  
Kaunas 44110 Lithuania

 2797